

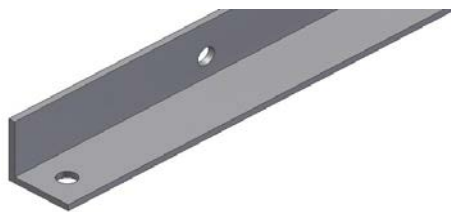





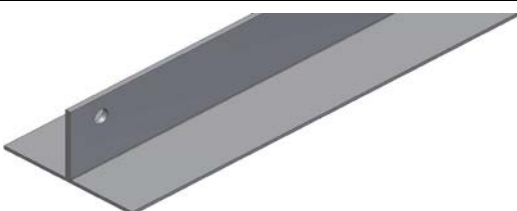
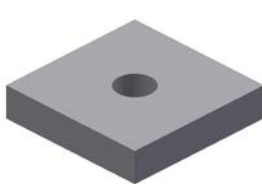

## Držák pro sluneční kolektor / Support bracket for solar collector

Rovná střecha - trojúhelníková podpěra 25° kód 10975 / Flat roof - triangle bracket 25° code 10975

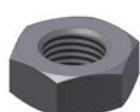
Obrázek Fig.	Označení Name	Rozměr Dimensions	Množství Qty	Kód dílu Code
	Profil "L" 30x30x3 hliník / L-beam 30x30x3 in aluminum	Délka 1860 mm / Length 1860 mm	1 ks / 1 piece	<b>9470</b>
	Profil základní "H"- hliník / Basic H-beam in aluminum	Délka 820 mm / Length 820 mm	1 ks / 1 piece	<b>11095</b>
	Profil základní "T" č.12197 - hliník / T- beam no.12197 in aluminium	Délka 1700 mm / Length 1700 mm	1 ks / 1 piece	<b>9469</b>
	Podložka držáku Al /Square washer for collector support, aluminum	32x32 tl. 8 mm / 32x32, 8 mm thick	2 ks / 2 pcs	<b>9405</b>
	Šroub M8x45 nerez (imbus) DIN 912/A2 / Socket screw M8x45, stainless steel DIN 912/A2	<b>M8x45</b>	2 ks / 2 pcs	<b>9564</b>
	Šroub M8x16 nerez (imbus) DIN 912/A2 / Socket screw M8x16, stainless steel DIN 912/A2	<b>M8x16</b>	1 ks / 1 piece	<b>6926</b>
	Matice M8 nerez DIN 934/A2 / M8 Hex nut, stainless steel DIN 934/A2	<b>M8</b>	5 ks / 5 pcs	<b>8381</b>
	Podložka 8,4 nerez DIN 125/A2 / 8.4 Flat washer, stainless steel DIN 125/A2	pr.8,4 mm / diam. 8.4 mm	3 ks / 3 pcs	<b>7256</b>
	Podložka vějířová vnější ozubení 8,4 DIN 6798 A/A2 nerez /Serrated tooth washer, 8.4, DIN6798 A/A2, stainless steel	pr.8,4 mm / diam. 8.4 mm	5 ks / 5 pcs	<b>8382</b>
	Šroub M8x30 velká hlava - pro základní profil / M8x30 bolt with big T head, for H-beam	<b>M8x30</b>	2 ks / 2 pcs	<b>8369</b>
	Krytka H profilu / H-rail end plug		1 ks / 1 piece	<b>11773</b>

**Sestavení držáků pro sluneční kolektory,  
pro rovné střechy - zvýšení úhlu o 25°.**

*Assembly of triangle brackets for solar collectors,  
for flat roofs - angle increase by 25°.*

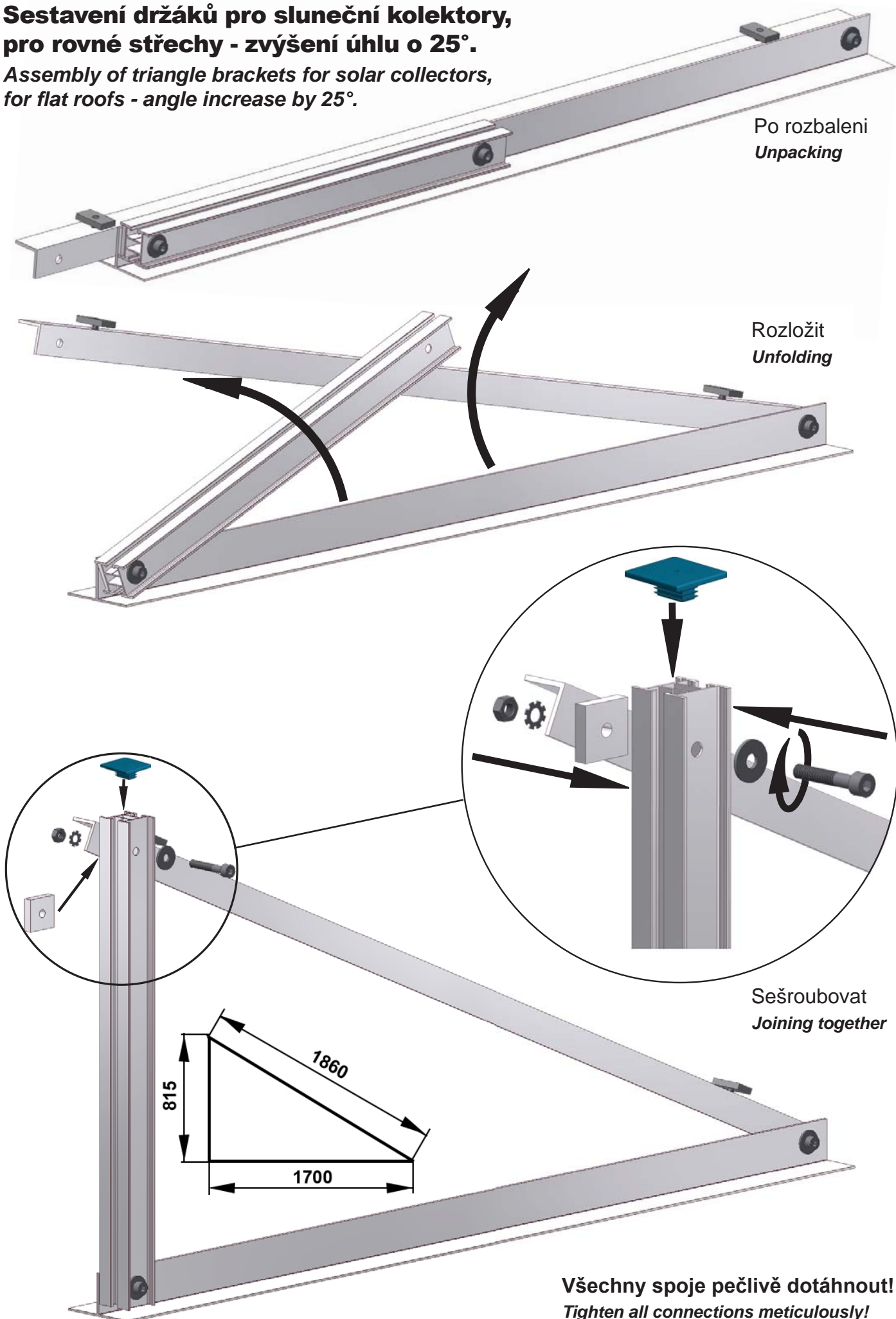

Po rozbalení  
*Unpacking*

Rozložit  
*Unfolding*

Sešroubovat  
*Joining together*

**Všechny spoje pečlivě dotáhnout!**  
*Tighten all connections meticulously!*